

Plastic bodied limit switch Series TI2

Description **TI2-SU1Z RIW**

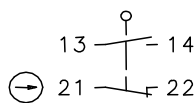

Article number **6088167008**

Operating symbol

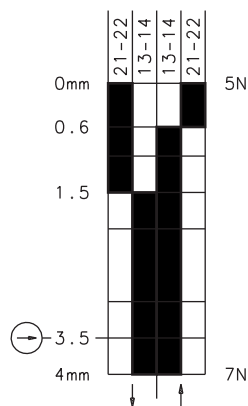

Operating diagram



 On
 Off
 Tolerance:
 Operating point $\pm 0,25$ mm;
 Operating torque ± 10 %

Fixed positioning with
e.g. fixing screw M5
according to the standard
DIN EN ISO 4762.

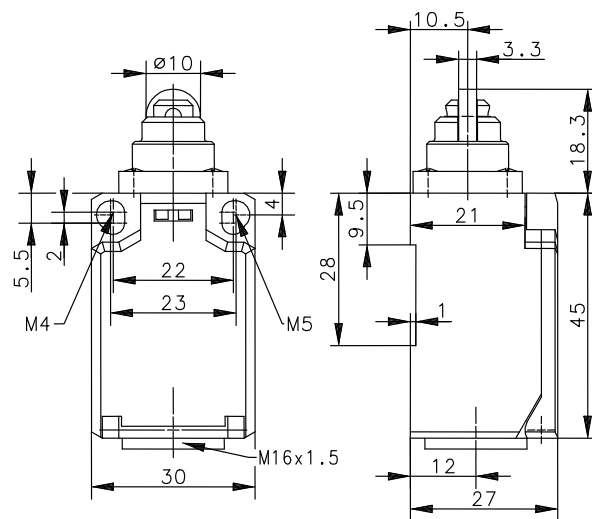
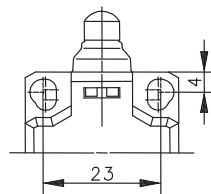

Electrical Data

Rated insulation voltage	U_i	250 V AC
Conv. thermal current	I_{the}	10 A AC; 2,5 A DC
Rated operational voltage	U_e	240 V AC; 250 V DC
Utilization category		AC-15, U_e/I_e 240 V / 3 A; 120 / 6 A DC-13, U_e/I_e 250 V / 0,27 A; 125 V / 0,55 A
Direct opening action		acc. to IEC/EN 60947-5-1, Annex K
Short-circuit protective device		Fuse 6 A gG
Protection class		II, totally insulated

Mechanical data	
Enclosure	Thermoplastic, glass fibre reinforced (UL 94-V0)
Cover	Thermoplastic, glass fibre reinforced (UL 94-V0)
Actuator	Roller (thermoplastic)
Ambient air temperature	-30 °C ... +80 °C
Contact type	1 NC, 1 NO (Zb)
Mechanical life	3 x 10 ⁶ operating cycles
Switching frequency	≤ 100 / min.
Assembly	2 x M4 or 2 x M5 fixed position for safety applications
Connection	4 screw connections (M3.5)
Conductor cross-sections	Solid: 0.5 ... 1.5mm ² Litz wire with ferrules: 0.5 ... 1.5mm ²
Cable entrance	1 x M16 x 1,5
Weight	≈ 0,05 kg
Installation position	operator definable
Protection type	IP65 acc. to EN 60529

Actuation
<p>The actuating device is preferably started from 2 sides. By loosening the 4 screws the actuation assembly can be rotated in 90 degree increments such that 4 actuation directions are possible. The actuation assembly is to be again fastened to the housing using the 4 screws.</p>

Standards
VDE 0660 T100, DIN EN 60947-1, IEC 60947-1
VDE 0660 T200, DIN EN 60947-5-1, IEC 60947-5-1

EU Conformity
acc. to directive 2014/35/EU

Approvals
cCSA _{US} A300 (same polarity)
CCC
UL

Notes
The degree of protection (IP code) specified applies solely to a property closed cover and the use of an equivalent cable gland with adequate cable.